

DELETING IMAGES



Your camera lets you use any one of the following four methods to delete images from its memory. You can delete the currently displayed image, one or more selected images, all the images in one or more selected folders, or all the images in the camera's memory.

IMPORTANT!

- Image deletion cannot be undone. Before deleting an image, make sure you no longer need it or you have a back-up copy saved on your computer, on diskette, or on some other medium. Be especially careful with "Deleting All Unprotected Images" operation, which deletes all unprotected images in memory.
- A protected image cannot be deleted. See "Protecting Images Against Deletion" on page E-116 for details on protecting and unprotecting images.
- Delete operations are disabled when all of the images on the camera's memory card are protected.

Deleting the Displayed Image

Use the following procedure when you want to delete the image that is currently on the monitor screen.

1. Enter the **PLAY** mode.
2. Use **[+]** and **[-]** to scroll through images and display the image you want to delete.
3. Press  .
4. In response to the confirmation message that appears, use **[+]** and **[-]** to select "Yes".
 - If you change your mind and do not want to delete the image, select "No" instead.
5. Press the shutter release button.
 - Displaying a panorama or movie image in step 2 of the above procedure causes all of the images that make up the panorama or movie to be deleted.

NOTE

- The camera does not maintain open spaces in its memory. Deleting an image causes images following the deleted image to be shifted up to fill in the empty space created by the deletion.

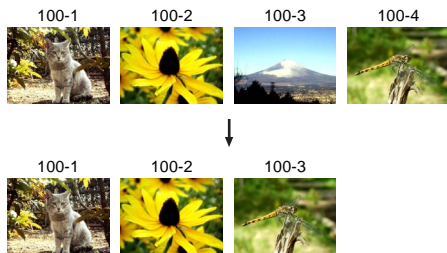



Deleting Selected Images

The following procedure lets you select one or more image for deletion.

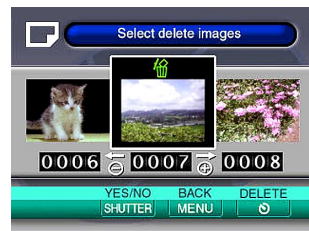
- 1. Enter the PLAY mode.**
- 2. Press MENU.**
- 3. Select “DELETE” → “Select”, and then press the shutter release button.**
- 4. Use [+] and [-] to display the image you want to delete.**
- 5. Press the shutter release button to toggle the displayed image’s icon on and off.**



- Any image marked with the  icon is marked for deletion. It will be deleted when you perform the next step of this procedure.
- Note that the image that was on the monitor screen when you pressed MENU in step 2 appears first with its  icon turned on.
- You can repeat steps 4 and 5 to mark and unmark multiple images if you want.

6. Press  .

7. In response to the confirmation message that appears, use [+] and [-] to select “Yes”.

- If you change your mind and want to cancel the delete, select “No” instead.



8. Press the shutter release button.

Deleting All Images in Selected Folders

Use the following procedure to select one or more folder for deletion of all their images.

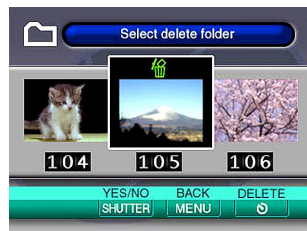
1. Enter the PLAY mode.
2. Press MENU.
3. Select “DELETE” → “Folder”, and then press the shutter release button.
4. Use [+] and [-] to display the folder whose images you want to delete.
5. Press the shutter release button to toggle the displayed folder’s  icon on and off.



- Any folder with the  icon is marked for deletion. All its images will be deleted when you perform the next step of this procedure.
- Note that the folder whose image was on the monitor screen when you pressed MENU in step 2 appears first with its  icon turned on.
- You can repeat steps 4 and 5 to mark and unmark multiple folders if you want.

6. Press  .

7. In response to the confirmation message that appears, use [+] and [-] to select “Yes”.

- If you change your mind and want to cancel the delete, select “No” instead.

8. Press the shutter release button.

Deleting All Unprotected Images

Use the following procedure when you want to delete all of the images currently on the camera’s memory card.

1. Enter the **PLAY** mode.

2. Press **MENU**.

3. Select “**DELETE**” → “**All**”, and then press the shutter release button.

4. In response to the confirmation message that appears, use [+] and [-] to select “**Yes**”.

- If you change your mind and want to cancel the delete, select “No” instead.

5. Press the shutter release button.

MANAGING IMAGES

The image management capabilities of the camera make it easy to keep track of images. You can protect images against deletion, and even use its DPOF feature to specify images for printing.

Folders and Files

Whenever you shoot an image, the camera automatically creates a folder for the current date (as kept by the camera's built in clock). Any images you shoot on a particular day are all stored as image files inside the same folder.

- For full details about the organization of folders on the memory card, see "Using a Memory Card to Transfer Image Data" on page E-135.

Folders

A folder is created automatically whenever you shoot the first image on a particular date. The name assigned to the folder is based on the current date, as described below. You can have up to 900 folders on a memory card at the same time (subject to storage capacity restrictions).

Example: Folder created on July 19, which is the 100th folder on the memory card

Month
|
Day
|
100_0719
|
Underbar
Serial number

- The actual number of files you will be able to store on a memory card depends on the capacity of the card, image quality settings, etc.

Files

Each folder can contain up to 250 image files. If you try to save the 251st image to a folder, the camera automatically creates a new folder and stores the image there. The names assigned to files are based on the current date, as shown below.

Example: 26th image shot on November 7

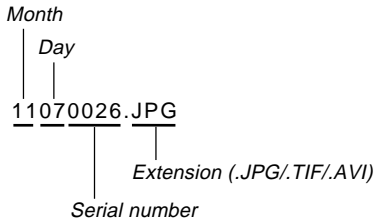

- In addition to image files, memory cards also contain a number of other files used by the system for image data management.
- The actual number of files you will be able to store on a memory card depends on the capacity of the card, image quality settings, etc.
- Panorama images are stored as groups of multiple individual images.
- If there are more than 250 image files in a folder (due to copying from another digital camera or other source), only the first 250 (in name sequence) can be played back.

Selecting a Folder for Playback

Use the following procedure to select a particular folder and play back the image files it contains.

1. Enter the **PLAY** mode.
2. Press **⏮**.
3. Use **[+]** and **[-]** to select the folder you want, and then press the shutter release button.
 - This displays the image of the first file (in name sequence) contained in the folder you selected.

Protecting Images Against Deletion





Image protection guards against accidental deletion of images stored on the camera's memory card. A protected image cannot be deleted until it is unprotected (page E-110). You can protect and unprotect a single specific image, all the images in a particular folder, or all images currently on the memory card.

Protecting Selected Images

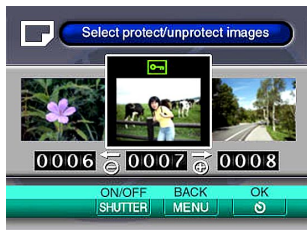
1. Enter the **PLAY** mode.
2. Press **MENU**.
3. Select **"PROTECT"** → **"Select"** and then press the shutter release button.
4. Use **[+]** and **[-]** to display the image you want to protect.

5. Press the shutter release button to toggle the displayed image's  icon on and off.





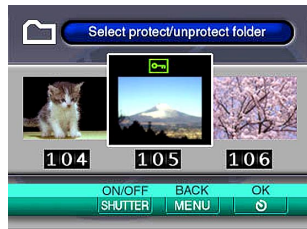

- Any image marked with the  icon is marked for protection. It will be protected when you perform the next step of this procedure. Any image without the  icon will be unprotected.
 - You can repeat steps 4 and 5 to turn on the  icon for multiple images if you want.
6. Press   to protect all the images marked for protection, and unprotect the unmarked images.

Protecting and Unprotecting All Images in Selected Folders

1. Enter the PLAY mode.
2. Press MENU.
3. Select "PROTECT" → "Folder", and then press the shutter release button.
4. Use [+] and [-] to display the folder whose images you want to protect.
5. Press the shutter release button to toggle the displayed folder's  icon on and off.



- Any folder with the  icon is marked for protection. All its images will be protected when you perform the next step of this procedure. All images in any folder without the  icon will be unprotected.
 - You can repeat steps 4 and 5 to turn on the  icon for multiple folders if you want.
- 6. Press   to protect the images in all the folders marked for protection, and unprotect the images in the unmarked folders.**

Protecting and Unprotecting All Images

- 1. Enter the PLAY mode.**
- 2. Press MENU.**
- 3. Select “PROTECT” → “All”, and then press the shutter release button.**
- 4. Select the memory protection setting you want, and then press the shutter release button to apply it.**

To do this	Select this
Protect all images on the memory card	On
Unprotect all images on the memory card	Off

DPOF

The letters “DPOF” stand for “Digital Print Order Format”, which is a format for recording on a memory card or other medium which digital camera images should be printed and how many copies of the image should be printed. Then you can print on a DPOF-compatible printer or at a professional print service from the memory card in accordance with the file name and number of copies settings recorded on the card.



■ DPOF Settings

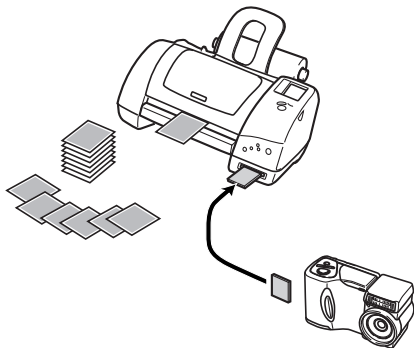

File Name, number of copies, date







Making DPOF Settings for Particular Images



1. Enter the **PLAY** mode.
2. Press **MENU**.
3. Select “DPOF” → “Select”, and then press the shutter release button.
4. Use **[+]** and **[-]** to display the image you want to print.
5. Use the button operations described below to make the DPOF settings you want.



To do this	Press this button
Decrease the number of copies value	SHIFT INFO
Increase the number of copies value	
Toggle printing of the recording date on and off	 /∞/MF RESIZE



- An image selected for printing is marked by the  icon.
 - An image for which printing of the recording date is turned on is marked with the  icon. Note that some printers may not support recording date printing.
 - You can repeat steps 4 and 5 to make DPOF settings for multiple image files, if you want.
- 6. After you are finished making the settings you want, press   to complete the procedure.**

Making DPOF Settings for Particular Folders



- 1. Enter the PLAY mode.**
- 2. Press MENU.**
- 3. Select “DPOF” → “Folder” and then press the shutter release button.**
- 4. Use [+] and [-] to display the folder whose images you want to print.**
- 5. Use the same procedures as those described in step 5 under “Making DPOF Settings for Particular Images” on page E-119 to make the DPOF settings you want.**
- 6. After you are finished making the settings you want, press   to complete the procedure.**

Making DPOF Settings of All Images on the Memory Card

1. Enter the PLAY mode.
2. Press MENU.
3. Select “DPOF” → “All”, and then press the shutter release button.
4. Use the button operations described below to make the DPOF settings you want.

To do this	Press this button
Decrease the number of copies value	SHIFT INFO
Increase the number of copies value	
Toggle printing of recording dates on and off	 /∞/MF RESIZE



5. After you are finished making the settings you want, press   to complete the procedure.

PRINT Image Matching

This camera supports PRINT Image Matching, which means that images recorded with it include information about the mode settings, camera setup, etc. When you print an image on a printer that supports PRINT Image Matching, the printer reads this data and adjusts the printed image accordingly, so your images come out just the way you intended when you recorded them. See the documentation that came with your printer for full details about PRINT Image Matching.

* PRINT Image Matching is a term for the print command that is embedded in header file of the image created by Digital Camera. It contains color setting and image parameter information.

**PRINT
Image
Matching**

OTHER SETTINGS

Turning the Monitor Screen Indicators On and Off

You can use the procedure below to turn the following monitor screen indicators on and off: exposure mode, memory capacity, image size, image protection indicator, folder name, file number, battery capacity.

1. Enter the REC mode or PLAY mode.
2. Select “Indicators” using one of the following two key operations, and then press the shutter release button.

If you are here	Select this on the menu screen
REC mode	“FUNCTION” → “SET UP” → “Indicators”
PLAY mode	“SET UP” → “Indicators”

3. Select the setting you want, and then press the shutter release button.

To do this	Select this setting
Turn on display indicators	On
Turn off display indicators	Off

Changing the Display Language

Use the following procedure to switch the display language between English and Deutsch.

1. Enter the REC mode or PLAY mode.
2. Press MENU.
3. Select “Language/Sprache” using one of the following two key operations, and then press the shutter release button.

If you are here	Select this on the menu screen
REC mode	“FUNCTION” → “SET UP” → “Language/Sprache”
PLAY mode	“SET UP” → “Language/Sprache”

4. Select the setting you want, and then press the shutter release button.

To do this	Select this setting
Display on-screen text in English	English
Display on-screen text in Deutsch	Deutsch

Turning the Confirmation Beep On and Off

Use the following procedure to turn the beep that sounds each time you press a button on and off.

1. Enter the REC mode or PLAY mode.
2. Press MENU.
3. Select “Beep” using one of the following two key operations, and then press the shutter release button.

If you are here	Select this on the menu screen
REC mode	“FUNCTION” → “SET UP” → “Beep”
PLAY mode	“SET UP” → “Beep”

4. Select the setting you want, and then press the shutter release button.

To do this	Select this setting
Turn on the confirmation beep	On
Turn off the confirmation beep	Off

CONNECTING TO EXTERNAL EQUIPMENT

Your camera has three terminals for connection to external equipment: a VIDEO OUT terminal, a DIGITAL terminal, and a USB port. You can use these terminals to connect the camera to a television, VCR, computer, or other external equipment. The QV-2900UX also includes an external flash sync terminal that can be used to connect a commercially available flash unit.

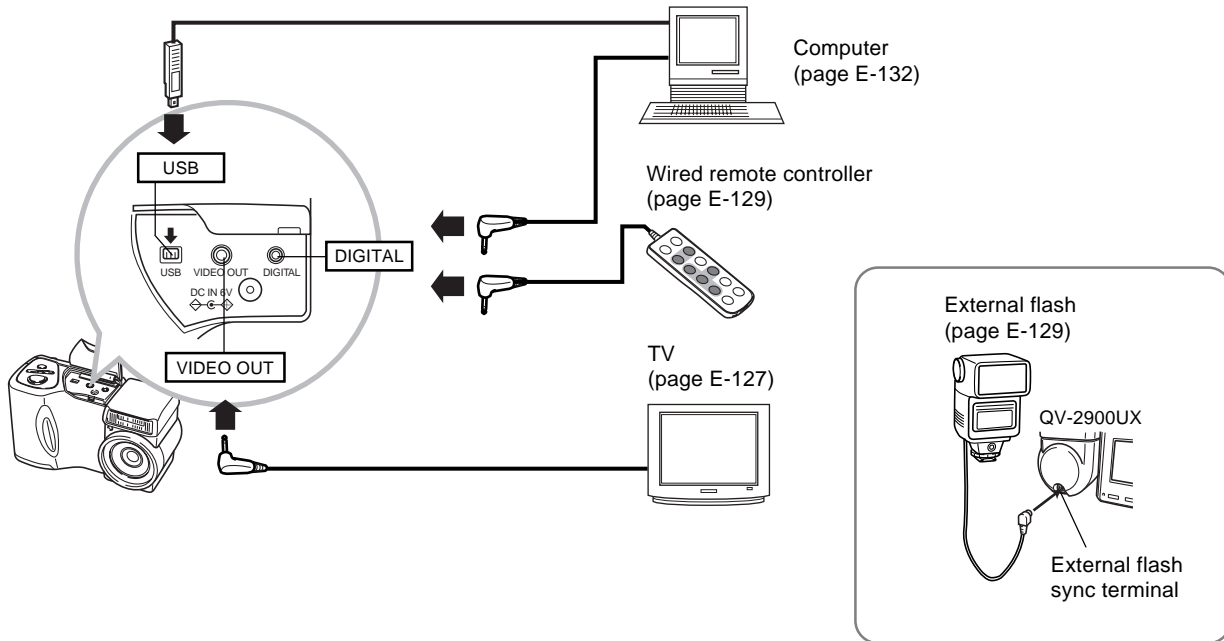

IMPORTANT!

- Be sure to turn off both the camera and the other equipment before making any connections.
- Check the documentation that comes with your other equipment for information you may need to know when making connections.
- Leaving the same image displayed on a television or computer display screen for very long periods can cause the image to be “burned in” on the screen. When this happens, a faint after-image remains on the screen, even after you disconnect the camera. To avoid this, you should not leave the same image displayed on such a screen for very long periods.
- This camera does not support cable transfer of data with other CASIO digital cameras.

Connecting to a Television

Images being displayed on the camera’s monitor screen, whether for recording or playback can also be displayed on the screen of a connected television. Connect the camera to a TV as illustrated below.

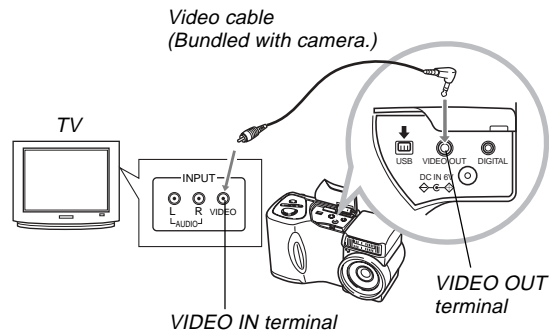

1. Use the video cable to connect the camera to the television as shown in the illustration.
2. Perform the required operation on the TV to set it up for video input.
 - See the documentation that comes with your television for information about how to do this.
3. Perform normal playback and recording operations on the camera.

IMPORTANT!

- Icons and other indicators that normally appear on the camera's monitor screen will also appear on the screen of the connected TV.

Selecting the Video Output Signal Mode

Your camera supports both NTSC (used in U.S., Japan, and other countries) and PAL (used in Europe and other areas) video output signal systems. The video system you should use depends on the country of origin of the equipment you are connecting to the camera's VIDEO OUT terminal.

IMPORTANT!

- When you have PAL selected as the video signal output mode, the monitor screen is turned off when you connect the cable to the VIDEO OUT terminal.

1. Enter the REC mode or PLAY mode.
2. Press MENU.
3. Select "VIDEO OUT" using one of the following two key operations, and then press the shutter release button.

If you are here	Select this on the menu screen
REC mode	"FUNCTION" → "SET UP" → "VIDEO OUT"
PLAY mode	"SET UP" → "VIDEO OUT"

4. Use [+] and [-] to select "NTSC" or "PAL", and then press the shutter release button.

Connecting the Wired Remote Controller to the Camera





The optionally available wired remote controller lets you operate the camera with touching it. This capability helps to avoid the effects of unintended camera movement when shooting at slow shutter speeds or with high telephoto settings with the camera mounted on a tripod. You can also use it to scroll through images during presentations on a TV screen. For more information about using the wired remote controller, see the instructions that come with it.

Wired Remote

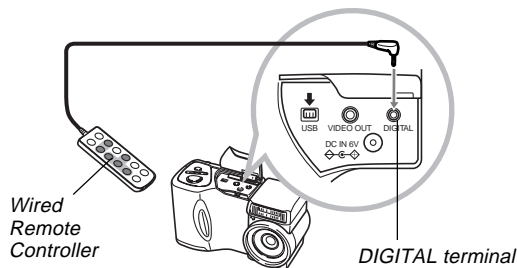
Controller Model: WR-2C (option)

Approximate Cable Length: 1 meter



- You can perform the following operations using the wired remote controller: shutter release, zoom slider, MENU, , , [+], [-], SHIFT INFO, , , .

Connecting an External Flash Unit (QV-2900UX Only)

Use of a commercially available flash unit makes it possible to obtain a higher level of brightness (guide number) than you get when using the built-in flash alone. An external flash also makes it possible to extend the effective range of flash photography.

- The guide number of the internal flash is 9 (ISO 100/m).

External Flash Unit Requirements

The external flash unit you use with your camera must satisfy the following requirements.

- Configuration: tripod hole mountable grip type with sync cable; or tripod hole mountable with grip-equipped bracket and sync cable
- Coverage Angle: Coverage of 40mm equivalent 35mm focal length lens (without wide conversion lens)
- Some flash performance may be lost when using a ring flash or other type of unit with a long flash time.
- The aperture values and ISO sensitivity available with some flash units may not match the values supported by your camera. In such a case, make adjustments in the aperture and ISO sensitivity settings of the external flash and the camera until proper brightness is achieved.
- Some flash performance may be lost when using a zoom flash.

Attaching an External Flash Unit

Always make sure that the external flash unit is turned off before attaching it to detaching it from the camera. Leaving the flash unit on can cause it to fire unexpectedly.

- 1. Point the lens of the camera straight forward, so it matches the optical axis of the external flash.**
- 2. Attach the external flash unit to its bracket, and affix the bracket to the camera's tripod hole.**
 - If you are using a grip type flash unit, affix the flash unit directly to the camera's tripod hole.
- 3. Remove the terminal cap and attach the flash unit's sync cable to the external flash sync terminal.**

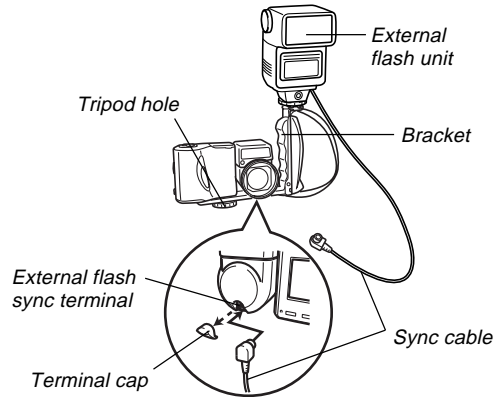

- Make sure you do not misplace the terminal cap. Always keep the terminal covered when an external flash unit is not connected.

4. Turn on camera power and make the required camera settings.

- Exposure Mode: M (Manual Exposure)
- Shutter Speed: Around 1/60 (Actual setting should be in accordance with aperture setting.)
- For maximum brightness of areas that are not reached by flash illumination, use the camera's maximum aperture opening (F3.2).
- White Balance: Sunlight
- Flash Mode:  (Off)

5. Turn on the external flash unit and set it up for the camera's aperture (F) value (page E-83) and sensitivity value (page E-85).

- Depending on shooting conditions, proper exposure may not be obtained even if you properly set the auto aperture (F) value and ISO sensitivity of the flash unit to match those of the camera. If this happens, adjust the aperture value and ISO sensitivity settings of the flash unit and camera.

IMPORTANT!

- The external flash connected to the external flash sync terminal always fires. To record an image without using external flash, disconnect the sync cable from the terminal or turn off external flash unit power.
- After recording an image, check it on the monitor screen. If it is not what you expected, use the controls on the external flash unit to adjust flash intensity, and adjust the aperture and ISO sensitivity settings on the camera. Note that you cannot control external flash unit intensity using camera settings.
- Close up images often tend to be overexposed. If you are having overexposure problems, try adjusting the aperture and ISO sensitivity settings of the external flash unit and the camera. You can also try using the camera's built in flash to correct for overexposure.
- Note that the camera's built in flash fires whenever its Flash Mode setting is something other than  (Off). The camera's sensitivity is fixed at ISO 80 when the built-in flash is turned on.
- Improper installation of an external flash unit can cause it to fire unexpectedly or to misfire. Make sure you install the external flash unit correctly.

- Camera aperture (F) values are based on the widest optical zoom (1X). Using telephoto can cause slight lens darkness. Adjust the aperture and ISO sensitivity settings of the external flash unit and the camera as required when using optical zoom.
- When using a zoom flash, set the coverage angle of the flash for a focal distance of 40mm or less.
- The optical axis of the lens may not match that of the external flash unit, even if the lens is pointed straight forward. If this happens, try expanding the coverage angle (decreasing the guide number) of the flash unit.
- ISO sensitivity values for a digital camera are slightly different from those for silver oxide film. Because of this, you may have to make adjustments of the ISO setting of your external flash unit to obtain the desired results.

Connecting to a Computer

The CD-ROM disc that comes bundled with your camera includes special software (Photo Loader) that makes transfer of images from the camera to a computer quick and easy. The following types of computer connections are supported.

■ Windows

- USB port connection
- Serial port (RS-232C) connection

■ Macintosh

- USB port connection
- Photo Loader does not run on the Apple Macintosh. You can, however, use the USB cable to connect the camera to a Macintosh and upload images manually.

USB Port Connection (Windows, Macintosh)

The camera's USB port and accessories make it easy to connect to a computer equipped with a USB port for image data uploading and downloading. First install the USB driver software from the bundled CD-ROM disc on your computer, and then use its special USB cable to connect. Once connected, your computer recognizes the camera as an external storage device.

- See the documentation on “Bundled Software User’s Manual” for full details about connections, installing the USB driver, minimum computer system requirements, and other information.

■ Connecting to a Computer with the USB Cable

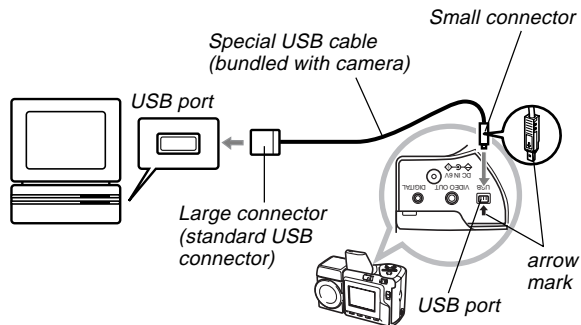

- Whenever connecting the USB cable to the camera, make sure the arrow mark on the plug is aligned properly with the arrow mark on the side of the camera's terminal.
- Plug the USB connectors into the ports as far as they will go. Incorrect connection can result in improper operation.
- The camera is not supplied power by the USB cable. Be sure to use the optional AC adaptor to power the camera whenever using a USB cable connection.
- Your camera requires a special QV Camera USB cable. Connection using a standard USB cable is not supported.

- Never disconnect the USB cable while a data communication operation is in progress. Doing so can corrupt memory data.
- USB data communication is supported in both the REC mode and PLAY mode.
- Be sure to disconnect the USB cable from the camera and computer after you are finished exchanging data.
- You cannot turn off the camera while the USB cable is connected. Disconnect the USB cable first when you want to turn off the camera.

Using a Serial Port Connection

You can connect a computer to the camera's DIGITAL terminal for image data uploading and downloading. For such a connection, you must install the Photo Loader software from the bundled CD-ROM disc on your computer, and use a separately available CASIO data transfer cable to make the connection. The type of cable you should use depends on what kind of computer you are connecting to.

- This manual covers actual physical connection procedures. See the documentation on the Bundled Software User's Manual for full details about connections, installing Photo Loader, and other information.

■ Windows

The Data Transfer Cable connects to an IBM PC/AT or compatible equipped with a D-Sub 9-pin RS-232C serial port, as shown below.

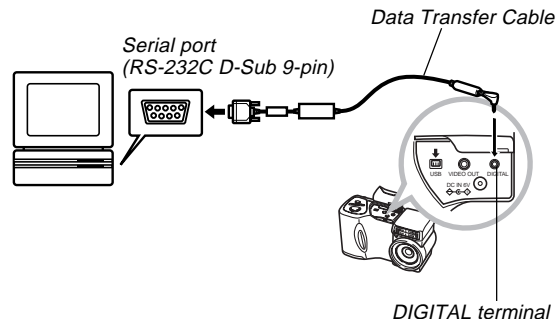

IMPORTANT!

- Be sure to turn off the camera, computer, and all peripherals connected to the computer (monitor, hard disk, etc.) before connecting the camera to the computer.
- After connecting the camera to the computer, slide the REC/PLAY selector to "PLAY", and then turn on the camera. Data communication with a computer is disabled while the camera is in the REC mode.
- Never connect or disconnect the cable while a data communication operation is in progress. Doing so can cause problems with program execution, can corrupt data, and can damage the camera and your computer.
- Data transfer while camera batteries are low can result in unexpected shutdown of the camera. Because of this, use of the optional AC adaptor is recommended whenever performing data communication with the camera.
- This camera does not support data communication with any of the optionally available CASIO PC link software applications: LK-1, LK-1A, LK-10V, LK-11W, LK-2, LK-2A, LK-2V, LK-21.

Using a Memory Card to Transfer Image Data

In addition to the cable connections described in the previous sections, you can also exchange data between your camera and computer by reading it directly from the memory card. The Photo Loader software that comes on the bundled CD-ROM disc automatically reads the images from the memory card and stores them in folders on your computer's hard disk.

The following provides general information about how to directly read images from a memory card. Certain details may be different depending on the type of computer you are using.

■ Computer Equipped with a CompactFlash Card Slot

Simply insert the memory card into your computer's CompactFlash card slot.

■ Computer Equipped with a PC Card Slot

For this configuration, you will need to purchase a separately available CASIO PC Card Adapter (CA-10). See the instructions that come with the PC Card Adapter for information about how to use it.

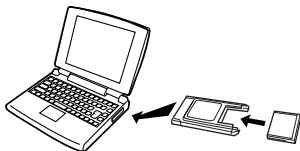

■ Another Computer

To access the contents on the memory card on a computer that does not have a CompactFlash card slot or PC card slot, use a commercially available PC card reader/writer in combination with a separately available CASIO PC Card Adapter (CA-10). See the instructions that come with the PC card reader/writer and the PC Card Adapter for information about how to use them.

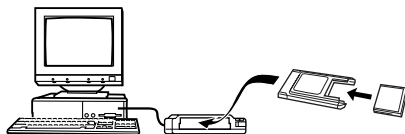

Memory Card Data

Images recorded with this camera and other data is stored on the memory card using DCF (Design rule for Camera File system) protocol. DCF protocol is designed to make it easier to exchange image and other data between digital cameras and other devices.

DCF Protocol

DCF devices (digital cameras, printers, etc.) can exchange images with each other. DCF protocol defines the format for image files data and the directory structure for the memory card, so images can be viewed using another manufacturer's DCF camera or printed on a DCF printer. In addition to support for the DCF protocol, your CASIO digital camera also use dates in image folder names and image file names, which helps to make data management easier.

Memory Card File Structure

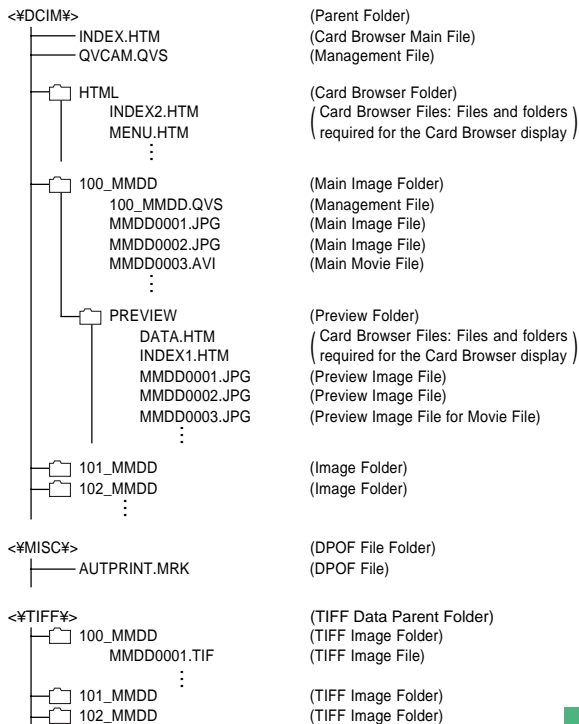

Folder and File Contents

- Parent Folder
Contents: All files used by the digital camera
- Card Browser Main File
Contents: Template for card browser, which is used for viewing image previews with a web browser
- Management File
Contents: Information about folder management, image sequence, etc.

- Card Browser Folder
Contents: Files used by the card browser
- Card Browser File
Contents: Data used by the card browser
- Main Image Folder
Contents: Image files recorded by the camera
- Main Image File
Contents: Still image file recorded by the camera
- Main Movie File
Contents: Movie file recorded by the camera
- Preview Folder
Contents: Preview images (hidden file)
- Preview Image File
Contents: Preview images of still image and movie files used for temporary playback and card browser previews
- DPOF File Folder
Contents: DPOF files
- TIFF Data Parent Folder
Contents: All TIFF format image related files
- TIFF Image Folder
Contents: TIFF format image files

- TIFF Image File
Contents: TIFF format image file
- Best Shot Folder
Contents: Sample images from CD-ROM
- Sample Image File
Best Shot Mode files

NOTE

- A memory card's actual file structure may differ somewhat in accordance with the type of Card Browser you are using (page E-140).

Image Files Supported by the Camera

- Image files recorded with the CASIO QV-2400UX or QV-2900UX Digital Camera
- DCF protocol image files
- Image file containing an image with a maximum width of 1,600 pixels and maximum height of 1,200 pixels.
- Maximum image file size of 1 Mbytes.

Certain DCF functions may not be supported.

Precautions when Using a Memory Card on a Computer

- This camera uses management files to manage the sequence and attributes of image files. Because of this, if you use your computer to modify or delete memory card files, to change management file contents, or to change image file sequence and attributes and then transfer the images back to the camera, you may end up with the wrong image sequence, ungrouped panorama images, and slow image scrolling.
- Note that the folder named “DCIM” is the parent (top) folder of all the files on a memory card. When transferring memory card contents to a hard disk, floppy diskette, MO disk, or other external storage, treat all the contents inside a DCIM folder as a set and always keep them together. Also, never use your computer to edit or delete the management files (those whose file names have the extension .QVS) inside a DCIM folder. You can change the name of the DCIM folder on your computer. Changing the name to a date is a good way to keep track of multiple DCIM folders. However, be sure you change the name of the DCIM folder back to “DCIM” before you copy it back to a memory card for playback on the camera. The camera does not recognize any folder name other than DCIM.
- The above is also true about the names of folders inside the DCIM folder. These folders must be returned to the names assigned to them by the camera whenever you copy the folder back to the memory card for playback on the camera.

- We also strongly recommend that after transferring data from a memory card to other external storage that you reformat the memory card and delete its contents before using it to record more images.
- The camera formats memory cards using ATA format, which means that a Macintosh sees all memory card files as text files. To view memory card files on a Macintosh, use PC Exchange to associate the files on the memory card (which are JPEG/TIFF files) with an application that is able to open JPEG/TIFF files.

Using the HTML Card Browser

The camera's Card Browser generates HTML files that let you see a table of image thumbnails for easy selection, and even view the properties of each image.

- Card Browser files can be viewed using the Web browsers listed below. Movie files require QuickTime.

Microsoft Internet Explorer 4.01 or later
Netscape Communicator 4.5 or later

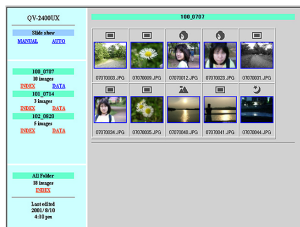

Specifying the Card Browser Type

1. Enter the **REC** mode or **PLAY** mode.
2. Press **MENU**.
3. Select **“Card Browser”** using one of the following two key operations, and then press the shutter release button.

If you are here	Select this on the menu screen
REC mode	“FUNCTION” → “SET UP” → “Card Browser”
PLAY mode	“SET UP” → “Card Browser”

4. Select the Card Browser setting you want.

When you want this	Select this
To turn off the Card Browser (no HTML files generated)	Off
Maximum performance, including access to image properties and slideshow capabilities <ul style="list-style-type: none"> This format uses high-level Java Script, and requires Microsoft Internet Explorer 4.01 or later or Netscape Communicator 4.5 or later. 	Type1
Light image viewing with access to image properties	Type2
Basic image viewing with slideshow capabilities <ul style="list-style-type: none"> This format uses high-level Java Script, and requires Microsoft Internet Explorer 4.01 or later or Netscape Communicator 4.5 or later. 	Type3
Basic image viewing	Type4

5. After selecting the setting you want, press the shutter release button.

- When a Card Browser type is selected, a file named "INDEX.HTM" is created inside the "DCIM" folder whenever you turn off the camera. Other files are also created and stored on the memory card at this time.
- Pressing  in place of the shutter release button in step 5 immediately starts creation of Card Browser files, which is indicated by the message "One moment please..." on the monitor screen. Never turn off camera power while this message is on the display.

NOTE

- If the memory card in the camera has a large number of files on it, it may take quite a bit of time for the camera to create the required HTML files and turn off. Because of this, we recommend that you normally leave the Card Browser turned off. We suggest that you turn off the Card Browser if you normally do not need to use it. The power down routine performed by the camera is much shorter when the Card Browser is turned off.

IMPORTANT!

- When the Card Browser is turned on, the monitor screen goes blank when you turn off the camera, but the operation lamp continues to flash for some time as the camera internally creates Card Browser files. Performing any of the operations listed below while the operation lamp is flashing not only stops creation of Card Browser files, it can also result in corruption of the image data on the memory card.
 - Opening the memory card slot cover
 - Unplugging the AC adaptor
 - Removing the camera's batteries
 - Other actions similar to those above
- Note that Card Browser files may be corrupted if batteries go low or if the memory card becomes full during file generation.
- You can specify the language for the Card Browser's on-screen text using the procedure under "Changing the Display Language" (page E-124).

Viewing Card Browser File Contents

Use your computer's Web Browser to view the contents of the Card Browser files.

- 1. Transfer the image data from the camera to your computer by cable (page E-132) or by accessing the memory card from your computer (page E-135).**
- 2. On the memory card, open the folder named "DCIM".**

3. Use your Web browser to open the file named "INDEX.HTM".

- This displays a gallery of thumbnails for all the images contained in the oldest image folder on the memory card.

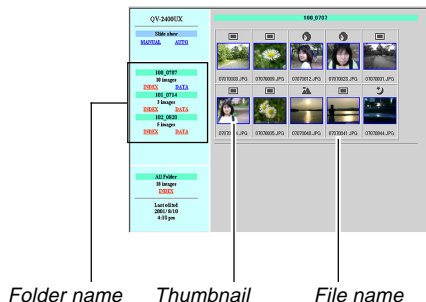

4. You can click the following items on the screen to perform the operations described below.

To do this	Click here
Start an automatic slideshow of full-screen size images (5-second interval)	AUTO
Start a manual slideshow of full-screen size images (image changes with click)	MANUAL

- Tapping an image on the INDEX screen or DATA screen displays a 640 x 480-pixel version of the image. Clicking the full-screen images displays the image in the size at which it was recorded.

IMPORTANT!

- Slideshow images are displayed in full-screen size, regardless of the size at which they were recorded.
- The thumbnail gallery uses the contents of the Preview Folder (page E-138). Images copied from another digital camera or a computer do not have preview images associated with them, so their thumbnails do not appear in the thumbnail gallery. If this happens, scroll through the images on the camera's monitor screen until the copied image appears. At this time, the camera automatically generates a preview image, which will now appear in the Card Browser thumbnail gallery.

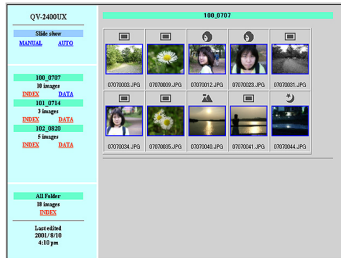

INDEX

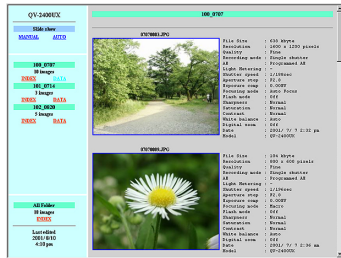

DATA

• Image Properties

The following is the information provided by the Image Properties screen.

- File Size : File size
- Resolution : Resolution
- Quality : Quality
- Recording mode : Recording mode
- AE : Exposure mode
- Light metering : Metering mode
- Shutter speed : Shutter speed
- Aperture stop : Aperture stop
- Exposure comp : Exposure compensation
- Focusing mode : Focusing mode
- Flash mode : Flash mode
- Sharpness : Sharpness
- Saturation : Saturation
- Contrast : Contrast
- White balance : White balance
- Sensitivity : Sensitivity
- Filter : Filter setting
- Enhancement : Enhancement setting
- Flash intensity : Flash intensity
- Digital zoom : Digital zoom setting
- Date : Recording date and time
- Model : Camera model name

- 5. To exit the Card Browser, simply quit your Web browser.**

Saving Card Browser Files

- To save Card Browser files, use a USB cable connection (page E-133) or memory card transfer (page E-135) to copy the folder named “DCIM” on the memory card to a hard disk, floppy diskette, MO disk, or other external storage. Never use your computer to edit or delete files, to add new images, or to delete images. Doing so will make it impossible to view image normally using the Card Browser.
- Never edit or delete any of the files inside the “DCIM” folder. You can use the Photo Loader application contained on the bundled CD-ROM disc to save Card Browser files. See the documentation that comes with Photo Loader on the disc for full details.
- We also strongly recommend that after transferring data from a memory card to other external storage that you reformat the memory card and delete its contents before using it to record more images.

REFERENCE

Camera Menus

The following shows lists of menus that appear in the REC mode and PLAY mode, and their settings.

- The settings that are underlined in the following table are initial defaults.
- “○” indicates items that can be included as part of a short-cut (page E-95).

REC mode

NORMAL			
PORTRAIT			
LANDSCAPE			
NIGHT SCENE			
BEST SHOT			
MOVIE			
MOVIE (PAST)			
PANORAMA			
INTERVAL			
FUNCTION	Size/Quality	1600 x 1200 / <u>Fine</u> 1600 x 1200 / Normal 1600 x 1200 / Economy 800 x 600 / Fine 800 x 600 / Normal 800 x 600 / Economy	○

FUNCTION	TIFF mode	<u>Off</u> / On	○
	Sensitivity	<u>ISO 80</u> / ISO 160 / ISO 320	○
	Filter	<u>Off</u> / B/W / Sepia / Red / Green / Blue / Yellow / Pink / Purple	○
	Exposure Mode	<u>P</u> / A / S / M	○
	Metering	<u>Multi</u> / Center / Spot	○
	White Balance	<u>Auto</u> / Daylight / Shade / Tungsten / Fluorescent / Manual	○
	Enhancement	<u>Off</u> / Red / Green / Blue / Flesh Tones	○
	Grid	<u>Off</u> / On	○
	Flash Intensity	Strong / <u>Normal</u> / Weak	○
	Sharpness	Hard / <u>Normal</u> / Soft	○
	Saturation	High / <u>Normal</u> / Low	○
	Contrast	High / <u>Normal</u> / Low	○
	Time Stamp	<u>Off</u> Year / Month / Day Day Hour:Minutes Year / Month / Day Hour:Minutes	○
	Digital Zoom	Off / <u>Auto</u> / X2 / X4	○
	Sleep	Off / 30sec / <u>1min</u> / 2min	○
	Auto Power Off	<u>2min</u> / 5min	○
	Best Shot setting	<u>Built-in + CF</u> / Built-in / CF	○
	Mode Memory	Recording Mode <u>Off</u> / On TIFF mode <u>Off</u> / On Sensitivity <u>Off</u> / On Exposure Mode <u>Off</u> / On	○ ○ ○ ○

FUNCTION	Mode Memory	Metering	Off / On	○
		White Balance	Off / On	○
		Flash	Off / <u>On</u>	○
		Focus	Off / On	○
		Digital Zoom	Off / <u>On</u>	○
		Flash Intensity	Off / On	○
	SET UP	Indicators	Off / <u>On</u>	○
		Card Browser	Off / Type1 / Type2 / Type3 / Type4	○
		Beep	Off / <u>On</u>	○
		Date Style	Year / Month / Day Day / Month / Year Month / Day / Year	○
		Date / Time	Time setting	○
		Language / Sprache	English / Deutsch	○
		Format	No / Yes	○
		Video Out	NTSC / PAL	○
		Link*	Off / Mode1 / Mode2 / Mode3	○
		Restore	No / Yes	○

* This function is not available with this model.

PLAY mode

SET UP	Indicators	Off / <u>On</u>
	Card Browser	Off / Type1 / Type2 / Type3 / Type4
	Beep	Off / <u>On</u>
	Date Style	Year / Month / Day Day / Month / Year Month / Day / Year
	Date / Time	Time setting
	Language / Sprache	English / Deutsch
	Format	No / Yes
	Video Out	NTSC / PAL
	Link*	Off / Mode1 / Mode2 / Mode3
	Restore	No / Yes
DELETE	Select / Folder / All	
DPOF	Select / Folder / All	
PROTECT	Select / Folder / All	
SLIDE SHOW		

* This function is not available with this model.

Mode Settings

Settings in Each Mode

○ : Available △ : Partially available × : Not available

		Partial Shutter Release Button Press		Flash Mode	Self-timer	Focus Frame Display
		AF Lock	AE Lock			
Recording Mode	Normal	○	○	○	○	○
	Portrait	○	○	○	○	○
	Landscape	○	○	○	○	○
	Night Scene	○	○	○	○	○
	Best Shot	○	○	○	○	○
	Movie (Normal)	×	×	×	○	×
	Movie (Past)	×	×	×	×	×
	Panorama	○	○	○	○	○
	Interval	○	○	○	×	○
Exposure Mode	P Mode	○	○	○	○	○
	A Mode	○	○	○	○	○
	S Mode	○	○	○	△	○
	M Mode	○	○	○	△	○

△ : The camera will not enter the Self-timer Mode while the shutter speed is set to "BULB".

Recording Mode + Exposure Mode Combinations



The following table shows to what extent each recording mode can be used in combination with each exposure mode.

○ : Available △ : Partially available × : Not available

		Exposure Mode			
		P Mode	A Mode	S Mode	M Mode
Recording Mode	Normal	○	○	○	○
	Portrait	○	○	○	○
	Landscape	○	○	○	○
	Night Scene	○	○	○	○
	Best Shot	○	○	○	○
	Movie (Normal)	○	○	×	×
	Movie (Past)	○	○	×	×
	Panorama	○	○	○	○
Interval	○	○	△	△	

△ : Entering the Interval Mode while "BULB" is selected as the shutter speed automatically changes the shutter speed to 1 second.

Troubleshooting

	Symptom	Probable Cause	Action
Power Supply	No power	<ol style="list-style-type: none"> 1. Batteries are not oriented correctly. 2. Batteries are dead. 3. Using the wrong AC adaptor. 	<ol style="list-style-type: none"> 1. Load batteries correctly (page E-32). 2. Replace batteries with a full set of new ones (page E-32). 3. Use only the specified AC adaptor.
	Sudden loss of power	<ol style="list-style-type: none"> 1. Activation of Auto Power Off (page E-37). 2. Dead batteries 3. QV-2400UX: Turning power on in the REC Mode while the lens cap is attached to the lens. 	<ol style="list-style-type: none"> 1. Turn power back on. 2. Replace batteries with a full set of new ones (page E-32). 3. QV-2400UX: Remove the lens cap and try turning power on again.
	 or  indicator on the monitor screen	Batteries are low.	Replace batteries with a full set of new ones (page E-32).
Recording	No recording when the shutter release button is pressed	<ol style="list-style-type: none"> 1. The REC/PLAY selector is set to "PLAY". 2. Flash unit is charging. 3. The message "MEMORY FULL" is on the monitor screen. 4. No memory card loaded in the camera 	<ol style="list-style-type: none"> 1. Slide to REC/PLAY selector to "REC". 2. Wait until flash unit charging is finished. 3. Delete images you no longer need from camera memory or change to another memory card. 4. Load a memory card.
	Unable to focus properly with Auto Focus	<ol style="list-style-type: none"> 1. Dirty lens 2. Subject is outside the focus frame. 3. Conditions make it impossible to obtain proper focus. 4. Camera is unsteady or shaking. 	<ol style="list-style-type: none"> 1. Clean the lens. 2. Compose the image so the subject is inside the focus frame. 3. Switch to the Manual Mode and focus manually (page E-58). 4. Use a tripod.

REFERENCE

	Symptom	Probable Cause	Action
Recording	Recorded image is blurred.	Improper focus	Make sure the subject on which you want to focus is inside the focus frame.
	Power failure during self-timer operation.	Batteries are dead.	Replace batteries with a full set of new ones (page E-32).
	Monitor screen image is out of focus.	<ol style="list-style-type: none"> Poor focusing in the manual focus mode. Attempting to record scenery or portraits in the Macro Mode. Attempting to use the Auto Focus mode for a subject that is too close. 	<ol style="list-style-type: none"> Focus the image (page E-58). Use Auto Focus for scenery and portraits. Use the Macro Mode for close ups.
	Recorded image is not saved.	<ol style="list-style-type: none"> Batteries going low before the image save operation is complete. Opening of the memory card slot cover before the image save operation is complete. 	<ol style="list-style-type: none"> Replace batteries with a full set of new ones. Keep the memory card cover closed until the image save operation is complete.
Playback	Colors of recorded image are different from those on the monitor screen.	<ol style="list-style-type: none"> Direct sunlight or light from another source shining into the lens. Image quality setting 	<ol style="list-style-type: none"> Reorient the camera so that light is not shining directly into lens. Change to a higher image quality for recording.
	[+] and [-] operations do not work while the 9-image view is on the monitor screen.	You are operating the [+] and [-] buttons while the scroll operation is still being performed.	Wait until image scrolling is complete before pressing [+] or [-].
	Cannot display a particular image.	Memory card images recording using a camera that does not support DCF.	The file management systems of cameras that do not support DCF are different from the one used by this camera. This camera cannot read cards recorded with such cameras.

REFERENCE

	Symptom	Probable Cause	Action
Playback	Monitor screen contents do not appear on the screen of a connected TV.	<ol style="list-style-type: none"> 1. Incorrect camera-TV connection 2. Wrong TV settings 3. Wrong video signal output mode 	<ol style="list-style-type: none"> 1. Connect correctly using the video cable (page E-127). 2. Check the documentation that comes with the TV and set it up correctly for video input. 3. Select the video output mode that suits the type of equipment you are using (page E-128).
Deletion	Cannot access the delete screen.	All images on the memory card are protected.	Unprotect the images you want to delete (page E-118).
Other	Cannot select menu items in the PLAY mode.	<ol style="list-style-type: none"> 1. Some functions cannot be selected for playback of certain types of images. 2. No images stored on the memory card. 	<ol style="list-style-type: none"> 1. Select a different function or change to another image. 2. Record an image to make the functions available.
	All buttons and switches are dead.	Circuit damage due to static electrical charge from connected device or due to strong impact.	Remove batteries and disconnect the AC adaptor if you are using one. Restore power and turn the camera on. If this does not work, contact your dealer or an authorized CASIO service provider.
	Nothing appears on the monitor screen.	<ol style="list-style-type: none"> 1. The monitor is asleep. 2. Communication over the USB cable is in progress. 	<ol style="list-style-type: none"> 1. Wake up the monitor (page E-37). 2. After the communication operation over the USB cable is complete, unplug the USB cable from the camera.

Messages

RECORD ERROR Some problem occurred when compressing image data to save it on the memory card. Shoot the image again.

There are no images on this memory card! There is no image data stored on the memory card.

This camera cannot display the image you selected! The image file you are trying to view is corrupted, or it was recorded with a camera whose image file format is not supported by this camera.

REPLACE BATTERY! Battery power is low. Camera power turns off automatically shortly after this message appears.

NO FORMAT → MENU The memory card you are using is not formatted. You must format the memory card before you can use it to store images (page E-41).

CF ERROR There is some problem with the memory card you are using. Perform the following procedure to correct the problem.

You must format the CompactFlash card before using it with this camera.

FORMAT → MENU

Warning!

The following procedure deletes all files currently stored on the memory card. Before proceeding, try to back up the contents of the memory card onto your computer's hard disk drive or some other type of external storage medium.

1. Press MENU.



2. Use [+] and [-] to select "Yes", and then press the shutter release button.

- To cancel this procedure, press MENU.
- Whenever formatting a memory card, be sure to use the AC adaptor to power the camera or replace its batteries with a full set of new alkaline or lithium batteries before starting. Unexpected loss of power can result in incomplete formatting and improper operation of the memory card.
- The message "There are no images on this memory card!" appears on the monitor screen after formatting is complete.



Insert memory card!

There is no memory card loaded in the camera. Load a memory card (page E-39).

MEMORY FULL

Change quality or delete unneeded images

There is not enough memory to record an image with your current quality and size settings. Change the image quality and size settings and try again, or delete some images from the memory card (page E-110).

MEMORY FULL
Delete unneeded
images

- There is not enough memory for further recording. Delete some images you don't need from memory card (page E-110).
- The DCIM folder or other file (page E-137) cannot be created due to insufficient memory when downloading data from a computer to the memory card. Use your computer to delete unneeded images to free up memory card space for the images you are downloading. You could also press the MENU button and format the memory card in the camera, but doing so deletes all image files currently stored on the memory card.

LENS CAP!

- This message appears and power turns off automatically if you turn on power while the REC/PLAY selector is set to "REC" and the lens cap is attached. Remove the lens cap and then turn on power (QV-2400UX only).
-

Specifications

- Description** Digital camera
- Model** QV-2400UX/QV-2900UX
- Recorded Image File Format** Still images (including panoramas): JPEG (Exif. Ver. 2.1) / TIFF, DCF standard (Design rule for Camera File system), DPOF compatible
Movies: AVI (Motion JPEG)
- Recording Medium** CompactFlash card (Type I/II), IBM Microdrive
- Recorded Image Size** 1600 x 1200 pixels, 800 x 600 pixels
- Standard Memory Capacity, Number of Image Files, Computer Output Image Size (JPEG images only)**

Still				
Image size (pixels)	Quality	File size	Number of images	
			8MB memory card	340MB Microdrive
1600 x 1200	FINE	850 KB/image	8 images	401 images
	NORMAL	600 KB/image	11 images	562 images
	ECONOMY	350 KB/image	19 images	943 images
800 x 600	FINE	200 KB/image	33 images	1587 images
	NORMAL	150 KB/image	43 images	2054 images
	ECONOMY	120 KB/image	53 images	2494 images

Movie (320 x 240 pixels)	
Storage Capacity	Approximately 300KB/second
Recording Time	16 seconds per movie

- The above figures are approximations only.

- Image Deletion** Single image; all images in a folder; all images in memory (with image protection)
- Imaging Element** 1/2.7-inch CCD (Total Pixels: 2.11 million, Effective Pixels; 2.02 million)
- Lens** • QV-2400UX
F2.8 to 4.5; f = 6.2 to 18.6mm (equivalent to 41 to 123mm lens for 35mm film)
• QV-2900UX
F3.2 to 3.5; f = 6 to 48mm (equivalent to 40 to 320mm lens for 35mm film)
- Zoom** • QV-2400UX
Optical zoom: 3X
Digital zoom: 12X
(in combination with optical zoom)
• QV-2900UX
Optical zoom: 8X
Digital zoom: 32X
(in combination with optical zoom)
Image size is 800 x 600 pixels when 4X digital zoom is used.
- Focusing** Contrast-detect Auto Focus; manual focus with macro mode and focus lock

Focus Range • QV-2400UX
 Normal focus: 10cm to ∞ (1X zoom)
 50cm to ∞ (3X zoom)
 Macro focus: 1cm to 50cm (1X zoom)
 Manual focus: 1cm to ∞ (1X zoom)
 50cm to ∞ (3X zoom)

• QV-2900UX
 Normal focus: 40cm to ∞ (1X zoom)
 1m to ∞ (8X zoom)
 Macro focus: 1cm to 50cm
 (1 to 1.6X zoom)
 Manual focus: 1cm to ∞ (1X zoom)
 1m to ∞ (8X zoom)

The focusing range is the distance from the lens surface to the subject.

Exposure Control

Light Metering: Multi-pattern, center point, spot by CCD
 Exposure: Program AE, Aperture priority AE, Shutter priority AE

Exposure Compensation: -2EV to +2EV (1/3EV units)

Shutter CCD electronic shutter; mechanical shutter, BULB, 60 to 1/2000 second

Aperture • QV-2400UX
 F2.8, F5.6, auto switching or manual switching
 • QV-2900UX
 F3.2, F4.8, F8, auto switching or manual switching

White Balance Automatic, fixed (4 modes), manual switching

Self-timer 10 seconds, 2 seconds

Built-in Flash

Flash Modes: AUTO, OFF, ON, Red eye reduction
 Flash Range: • QV-2400UX
 Approximately 0.5 to 2 meters
 • QV-2900UX
 Approximately 0.5 to 2.5 meters

Recording Functions Normal, movie, panorama, landscape, night scene, portrait, self-timer, macro, Best Shot, Interval

Monitor 1.8" TFT, low-glare color HAST LCD (122,100 pixels, 555 x 220)

Viewfinder LCD Monitor or optical viewfinder

Clock Built-in quartz digital timepiece for time and date recording and storage with image data; auto calendar up to 2049

Input/Output Terminals DIGITAL IN/OUT, USB port (special mini port), AC adaptor connector, VIDEO OUT (NTSC, PAL), External flash sync terminal (QV-2900UX)

Power Supply Four AA-size alkaline or lithium batteries
 Four AA-size nickel-metal hydride rechargeable batteries (NP-H3)
 AC adaptor (AD-C620)
 AC adaptor charger (BC-3HA)

Battery Life

The values noted below indicate the number of hours before battery failure under normal operating temperature (25°C). These values are for reference only, and do not guarantee that any particular set of batteries actually will provide the service life indicated. Low temperatures shorten battery life.

Type of Operation	AA-size Alkaline Batteries LR6	AA-size Lithium Batteries FR6	AA-size Ni-MH Batteries NP-H3
Continuous Playback	170 minutes	300 minutes	180 minutes
Continuous Recording	80 minutes (480 shots)	200 minutes (1200 shots)	120 minutes (720 shots)

- The above figures are approximations only.
- The above guidelines are based on the following battery types:
Alkaline: MX1500 (AA) DURACELL ULTRA
Lithium: Energizer
- Battery life varies with brand.

Continuous recording values show the number of shots without using the flash. The number of shots depends on use of the flash and whether flash is turned on or off.

Power Consumption • QV-2400UX Approximately 5.3W
• QV-2900UX Approximately 5.8W

Dimensions • QV-2400UX 118(W) x 67(H) x 54(D) mm
• QV-2900UX 121(W) x 80.5(H) x 66(D) mm

Weight • QV-2400UX Approximately 245g
• QV-2900UX Approximately 295g (excluding batteries)

Standard Accessories 8MB CompactFlash memory card, Strap; lens cap; cap holder; soft case (QV-2400UX); special USB cable; special video cable; data transfer cable; CD-ROM; four LR6 alkaline batteries; Basic Reference, Bundled Software User's Manual; Best Shot scene List

- This camera does not have a separate battery to power its clock. Clock settings are cleared whenever power to the camera is cut off (by batteries going dead while the camera is not connected to an AC power outlet with the AC adaptor) for about 24 hours. After power is resumed, either by loading fresh batteries or connecting to an AC power outlet, you will have to set the correct time and date again.
- The liquid crystal panel built into this camera is the product of precision engineering, with a pixel yield of 99.99%. This also means, however that 0.01% of the pixels can be expected to fail to light or to remain lit at all times.